

Do not dispose of electrical appliances as unsorted municipal waste, use separate collection facilities.

Contact your local government for information regarding the collection systems available.

If electrical appliances are disposed of in landfills or dumps, hazardous substances can leak into the groundwater and get into the food chain, damaging your health and well-being.

When replacing old appliances with new one, the retailer is legally obligated to take back your old appliance for disposal at least for free of charge..

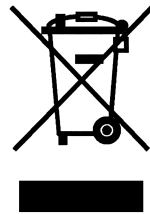

Distributed by:

A large, empty rounded rectangular box intended for the distributor's name.

TIME STAMP

ELECTRONIC TIME RECORDER

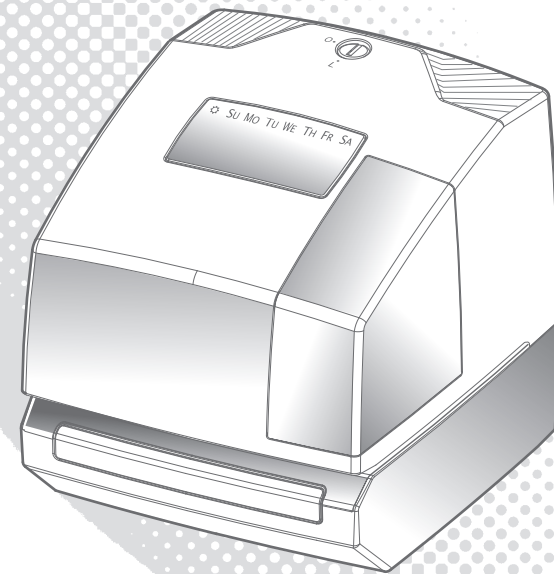



USER'S MANUAL





PRECAUTIONS







This user's manual is prepared for safe and proper use of the unit. Please follow all the instructions to avoid possible danger to yourself or others and damage to the unit.



Signs











Various warnings and cautions are provided throughout this manual along with signs. Remember each sign and its explanation listed below for your safety and proper operation of the unit.

	Warning	Improper handling may cause bodily accidents including death and serious injury.
	Caution	Improper handling may harm the human body or material.

	Improper handling may cause electric shock DANGER.		"Must Do" sign.
	DO NOT disassemble the unit.		Be sure to remove the line cord plug from the outlet.
	"Don't" sign.		

 Warning	
	Do not disassemble the unit. There is a high voltage present inside, possibly leading to an electric shock.
	Do not modify the unit. Modifications may cause a fire and/or electric shock.
	If any anomaly occurs, for example heat or smoke is generated or an odor is emitted, unplug the unit immediately and contact your dealer for servicing. There is a danger that further use may cause a fire or electric shock.
	Do not use any voltage of the power source other than designated. Do not share a single outlet with another plug. These may lead to fire or shock hazards.
	Do not damage, break, or modify the power cord. Do not put a heavy object on, pull, or forcefully bend the cord, either. These may damage the cord, possibly resulting in a fire or electric shock.

	If foreign matter should get in the unit (including a piece of metal, water, or liquid), disconnect the plug from the outlet immediately your dealer for servicing. There is a danger that further use may cause a fire or electric shock.
	Do not plug or unplug the unit with a wet hand. You may get an electric shock.

 Caution	
	Do not place the unit on an uneven or tilted surface. This may result in injuries due to the unit dropping or falling off.
	Do not put a water-filled container or a metal object on top of unit. If water is spilled or the metallic object slips inside, a fire or shock hazard may occur.
	Do not install the unit in a humid or dusty environment. It may cause a fire or electric shock.
	Do not place the unit near kitchen counter or humidifier. Oil, smoke, or steam generating from them may cause fire or shock hazards.
	Do not yank the power cord plug from the outlet before transferring the unit, or it may damage the cord, possibly leading to a fire or electric shock.
	Remove the line cord plug from the outlet before transferring the unit, or it may damage the cord, possibly leading to a fire or electric shock.
	Be careful not to contact the print head, as you may get hurt or burned.
	Make sure to insert the power plug as far as it will go. Improper insertion of the plug may develop fire or shock hazards.
	Do not insert or drop any other time card than specified into the slot. Such misuse may cause a fire or electric shock.
	If the unit should be dropped or the case be broken, unplug the unit and contact your dealer for servicing. Further use may lead to a fire or shock hazard.

Daily Care	
For cleaning, turn the power off and wipe the case clean of dust and dirt with a dry cloth, ect.	

TABLE OF CONTENTS

- COMPONENTS 1
- QUICK SITTING UP OF YOUR CLOCK 2
 - 3.1 Setting the time 3
 - 3.2 Setting the date 3
 - 3.3 Setting the print order 3

- ADVANCE FEATURES 4
 - 4.1 Setting the 12/24 hour format 4
 - 4.2 Setting the print pattern 5
 - 4.3 Setting the pre-programed comments 6
 - 4.4 Setting the language 7
 - 4.5 Setting the print method 8
 - 4.6 Setting the daylight saving time 9
 - 4.7 Setting the number 11
 - 4.8 Setting the initial number 12
 - 4.9 Setting the time table program 13
 - 4.10 Setting the customized comments 15

- HOW TO CORRECT CUSTOMIZED COMMENTS 17
- RESETTING 17
- REPLACING THE RIBBON CASSETTE 18
- INSTALLING THE Ni-Cd BATTERY (OPTIONAL) 19
- TROUBLE SHOOTING 20
- CHARACTER CODE FOR ALPHANUMERIC 21
 - Large (BOLD) character 21
 - Large character 22
 - Small character 23
 - Language-Specific character 24
- SPECIFICATION 25

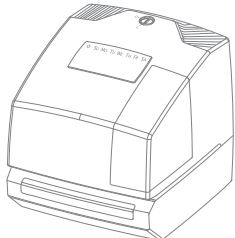

TIME STAMP

ELECTRONIC TIME RECORDER

USER'S MANUAL

COMPONENTS

Time stamp series

User's Manual

Keys....2 pcs.

Ribbon Cassette....1 pcs.

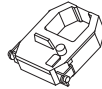
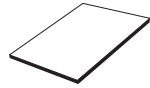

Name of parts

<Front view>

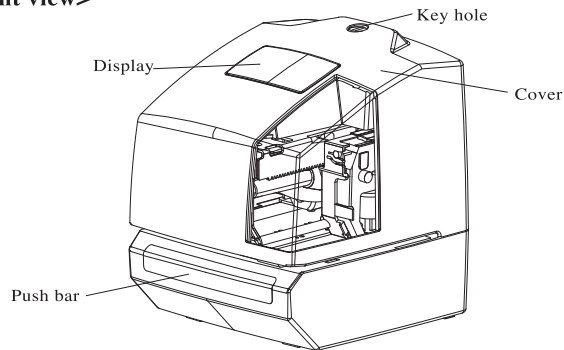

<Back view>

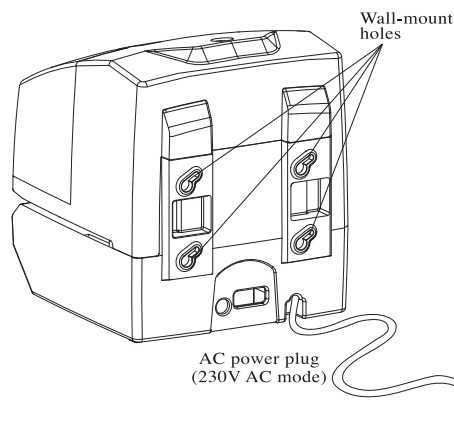

<Cover off>

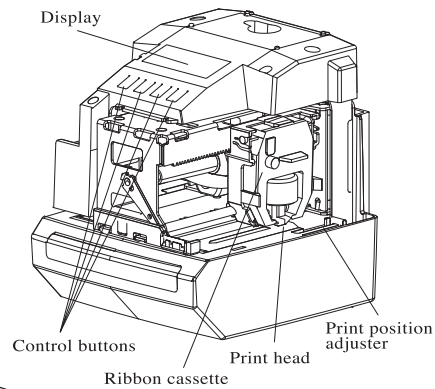

INITIALIZING THE CLOCK

Before starting this procedure, run a time card through the recorder to test the position of the punch on the card. Print position from the card edge is adjustable by pressing and sliding the print position adjuster located on the right outside bottom of the Time Stamp.

QUICK SETTING UP OF YOUR CLOCK

Function keys

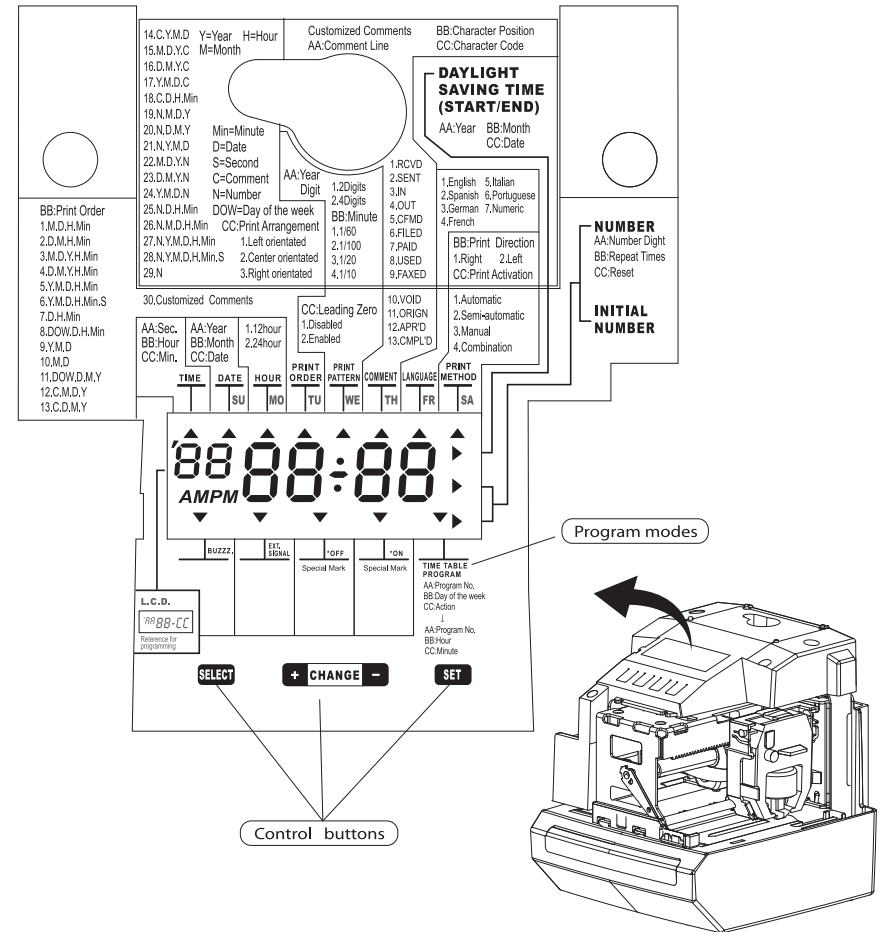

Press **SELECT** button repeatedly to choose the desired program mode for setting.
 Press **+ CHANGE** button to increase the setting value.
 Press **CHANGE -** button to decrease the setting value.
 Press **SET** button to confirm the setting value. Thereafter you press this **SET** button again, you can return the Time Stamp to the normal operation mode.

To enter the program setting mode, press the **SELECT** button once. Then the Time Stamp goes into the program mode showing the ▲ on the display labeled "TIME" mark.

3.1 SETTING THE TIME

1. Press the [SELECT] button repeatedly until the ▲ corresponds to the "TIME" on the setting panel.
2. Press[+][−] button to adjust hour and minute.
3. Press [SET] to confirm the setting value.
4. After you finish setting, press the [SET] button once again.



3.2 SETTING THE DATE

1. Press the [SELECT] button repeatedly until the ▲ corresponds to the "DATE" on the setting panel.
2. Press[+][−] button to adjust the current year; press [SET] to confirm the setting value.
3. Press[+][−] button to adjust month and date, press [SET] to confirm the setting value.
4. After you finish setting, press the [SET] button once again.



3.3 SETTING THE PRINT ORDER

1. Press the [SELECT] button repeatedly until the ▲ corresponds to the "PRINT ORDER" on the setting panel.
2. Press [+][−] button to choose the number correspond to the suitable print order on the setting panel.
3. Press [SET] to confirm the setting value.
4. After you finish setting, press the [SET] button once again.

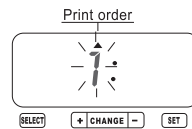

Y=Year, M=Month, D=Date, DOW=Day of the week, H=Hour, Min=Minute, S=Second
C=Comment, N=Number

	Print Order Options	Print Example		Print Order Options	Print Example
1.	M.D.H.Min	JAN 31 10:00	16.	D.M.Y.C	31 JAN '05 SENT
2.	D.M.H.Min	31 JAN 10:00	17.	Y.M.D.C	'05 JAN 31 SENT
2.	M.D.YH.Min	JAN 31 '05 10:00	18.	C.D.H.Min	SENT 31 10:00
4.	D.M.Y.H.Min	31 JAN '05 10:00	19.	N.M.D.Y	000123 JAN 31 '05
5.	Y.M.D.H.Min	'05 JAN 31 10:00	20.	N.D.M.Y	000123 31 JAN '05
6.	Y.M.D.H.Min.S	'05 JAN 31 10:00:00	21.	N.Y.M.D	000123 '05 JAN 31
7.	D.H.Min	31 10:00	22.	M.D.Y.N	JAN 31 '05 000123
8.	DOW.D.H.Min	FR, 31 10:00	23.	D.M.Y.N	31 JAN '05 000123
9.	Y.M.D	'05 JAN 31	24.	Y.M.D.N	'05 JAN 31 000123
10.	M.D	JAN 31	25.	N.D.H.Min	000123 31 10:00
11.	DOW.D.M.Y	FR, 31 JAN '05	26.	N.M.D.H.Min	123 JAN 31 10:00
12.	C.M.D.Y	SENT JAN 31 '05	27.	N.Y.M.D.H.Min	123 '05 JAN 31 10:00
13.	C.D.M.Y	SENT 31 JAN '05	28.	N.Y.M.D.H.Min.S	123 '05 JAN 31 10:00:00
14.	C.Y.M.D	SENT '05 JAN 31	29.	N	000123
15.	M.D.Y.C	JAN 31 '05 SENT	30.	Customized Comments	(Ref. P.15)

ADVANCE FEATURES

4.1 SETTING THE 12/24 HOUR FORMAT

1. Press the [SELECT] button repeatedly until the ▲ corresponds to the "HOUR" on the setting panel.
2. Press [+][−] button to choose the number "1" 12 hour mode or "2" 24 hour mode.

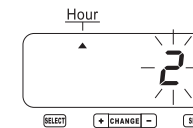
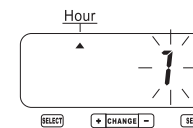

	Hour Format Options	Display
1.	12 hour	PM 3:00
2.	24 hour	15:00

3. Press [SET] to confirm the setting value.
4. After you finish setting, press the [SET] button once again.

4.2 SETTING THE PRINT PATTERN

1. Press the [SELECT] button repeatedly until the ▲ corresponds to the "PRINT PATTERN" on the setting panel.
2. Press [+] [-] button to choose "Year Digit Options".

	Year Digit Options	Print Example
1.	2 digits	JAN 31 '05 10:00
2.	4 digits	JAN 31 2005 10:00

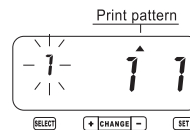

3. Press [SET] to confirm the setting value.
4. Press [+] [-] button to choose "Type of Minute".

	Type of Minute	Print Example
1.	1/60 Min.	JAN 31 2005 10:10
2.	1/100	JAN 31 2005 10:17
3.	1/20 Min.(=5/100 Min.)	JAN 31 2005 10:15
4.	1/10 Min.	JAN 31 2005 10:1

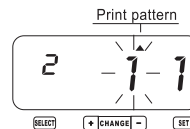

5. Press [+] [-] button to choose "Leading Zero".

	Leading Zero	Print Example
1.	ZERO Disabled	JAN 1 3:00
2.	ZERO Enabled	JAN 01 03:00

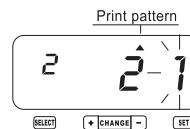

6. Press [SET] to confirm the setting value.
7. After you finish setting, press the [SET] button once again.

4.3 SETTING THE PRE-PROGRAMMED COMMENTS

1. Press the [SELECT] button repeatedly until the ▲ corresponds to the "COMMENT" on the setting panel.
2. Press [+] [-] button to choose the one of desired comment options.

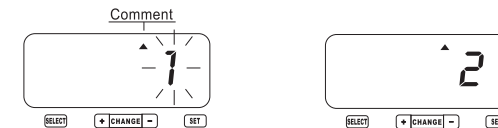

	Comment Options	Print Example
1.	RCVD (Received)	JAN 31 '05 RCVD
2.	SENT	JAN 31 '05 SENT
3.	IN	JAN 31 '05 IN
4.	OUT	JAN 31 '05 OUT
5.	CFMD (Confirmed)	JAN 31 '05 CFMD
6.	FILED	JAN 31 '05 FILED
7.	PAID	JAN 31 '05 PAID
8.	USED	JAN 31 '05 USED
9.	FAXED	JAN 31 '05 FAXED
10.	VOID	JAN 31 '05 VOID
11.	ORIGN (Original)	JAN 31 '05 ORIGN
12.	APR'D (Approved)	JAN 31 '05 APR'D
13.	CMPL'D (Completed)	JAN 31 '05 CMPL'D

3. Press [SET] to confirm the setting value.
4. After you finish setting, press the [SET] button once again.

4.4 SETTING THE LANGUAGE

1. Press the [SELECT] button repeatedly until the ▲ corresponds to the "LANGUAGE" on the setting panel.
2. Press [+] [-] button to choose the one of desired language for print.



	Print Language Options	Print Example
1.	ENGLISH	TH, 25 DEC '05 OUT 31 10:00
2.	SPANISH	JU, 25 DIC '05 SAL 31 10:00
3.	GERMAN	DO, 25 DEZ '05 AUSG 31 10:00
4.	FRENCH	JE, 25 DEC '05 SORT 31 10:00
5.	ITALIAN	GI, 25 DIC '05 USC 31 10:00
6.	PORTUGUESE	QI, 25 DEZ '05 SAIDA 31 10:00
7.	NUMERIC	4, 25-12 '05 OUT 31 10:00

3. Press [SET] to confirm the setting value.
4. After you finish setting, press the [SET] button once again.

4.5 SETTING THE PRINT METHOD

1. Press the [SELECT] button repeatedly until the ▲ corresponds to the "PRINT METHOD" on the setting panel.
2. Press [+] [-] button to choose the print direction.

	Print Direction Options
1.	Right
2.	Left

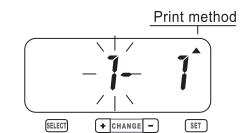

3. Press [SET] to confirm the setting value.
4. Press [+] [-] button to choose the Print Activation.

	Print Activation Options
1.	Automatic
2.	Semi-automatic
3.	Manual
4.	Combination

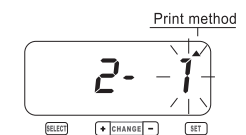

Automatic will allow the Time Stamp to print by simply inserting a card or piece of paper.

Semi-automatic will allow the Time Stamp to print by pressing the push bar only when a card or piece of paper is inserted.

Manual will allow the Time Stamp to print by pressing the push bar.

Combination will allow the Time Stamp to print by pressing the push bar or inserting a card or piece of paper.

5. Press [SET] to confirm the setting value.
6. After you finish setting, press the [SET] button once again.

4.6 SETTING THE DAYLIGHT SAVING TIME

D.S.T. execution time

This function will allow you to set the clock to automatically adjust the time to daylight saving time on the programmed date at 2:00 a.m. on the first day of summer time, the clock automatically gains one hour to show 3:00 a.m. When 3:00 a.m. comes on the last day of the summer time period, it loses one hour and returns to 2:00 a.m.

Set the starting date

1. Press the [SELECT] button repeatedly until the ▲ corresponds to the "DAYLIGHT SAVING TIME" on the setting panel.
2. Press [+] [-] button to select the current year.
3. Press [SET] to confirm the setting value.
4. Press [+] [-] button to select the beginning month for D. S. T.
5. Press [SET] to confirm the setting value.
6. Press [+] [-] button to select the beginning date for D. S. T.
7. Press [SET] to confirm the setting value.

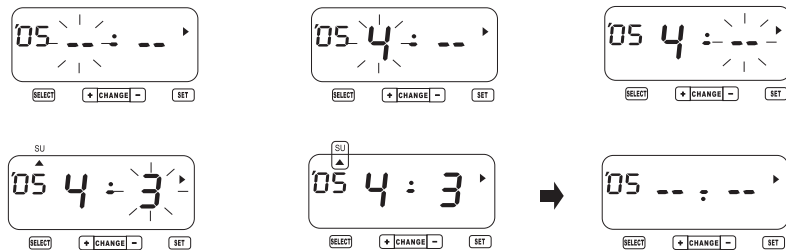

Set the ending date

8. Press [+] [-] button to select the year for the ending year for D. S. T.
9. Press [SET] to confirm the setting value.
10. Press [+] [-] button to select the ending month for D. S. T.
11. Press [SET] to confirm the setting value.
12. Press [+] [-] button to select the ending date for D. S. T.
13. Press [SET] to confirm the setting value.
14. After you finish setting, press the [SET] button once again.

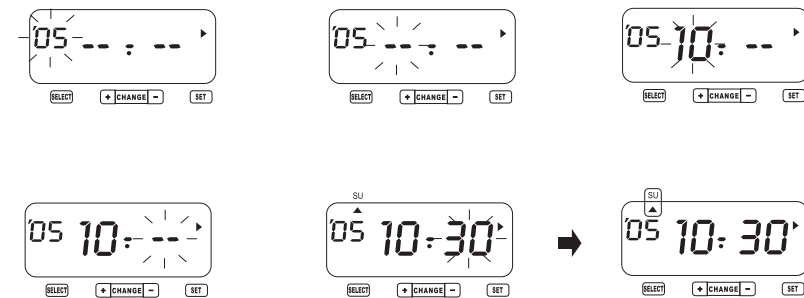

PS. To delete and cancel the daylight saving time settings, change the display of "Month" of the starting setting to "--".

4.7 SETTING THE NUMBER

1. Press the [SELECT] button repeatedly until the ▲ corresponds to the "NUMBER " on the setting panel.
2. Press [+][-] button to select the digits of printed number.

The Number Digit can be set from 1 to 8.

Print Example:

6 Digits of Number 123456 JAN 31 '05
 4 Digits of Number 1234 JAN 31 '05

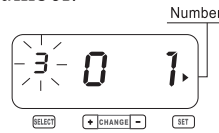

3. Press [SET] to confirm the setting value.
4. Press [+][-] button to select repeat times for print.

The Repeat Times can be set from 0 to 9.

Print Example:

0 time repeat→ (1st time) 123456 JAN 31 '05
 (2nd time) 123456 JAN 31 '05
 (3rd time) 123456 JAN 31 '05
 (4th time) 123456 JAN 31 '05
 (5th time) 123456 JAN 31 '05
 ∴ ∴

2 time repeat→ (1st time) 123456 JAN 31 '05
 (2nd time) 123456 JAN 31 '05
 (3rd time) 123457 JAN 31 '05
 (4th time) 123457 JAN 31 '05
 (5th time) 123458 JAN 31 '05
 ∴ ∴



5. Press [SET] to confirm the setting value.
6. Press [+][-] button to select the Reset Options

	Reset Options	Execution event of Reset.
1.	Disabled
2.	Return to INITIAL NUMBER	Change of date
3.	Return to 0	Change of date



7. After you finish setting, press the [SET] button once again.

4.8 SETTING THE INITIAL NUMBER

1. Press the [SELECT] button repeatedly until the ▲ corresponds to the " INITIAL NUMBER" on the setting panel.
2. Press [+][-] button to select the number of the first digit.
3. Press [SET] to confirm the setting value.
4. Press [+][-] button to select the number of the second digit.
5. Press [SET] to confirm the setting value.
6. Repeat step 2-5 to complete the initial number setting.

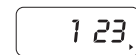
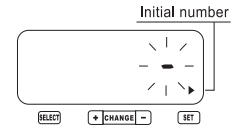

PS. The number of digits for "Initial Number" depends on the number set in the previous page. The maximum there are 8 digits of number which can be set.

7. Press [SET] to confirm the setting value.
8. After you finish setting, press the [SET] button once again.

4.9 SETTING THE TIME TABLE PROGRAM

The time table program function allows special mark "*" printing, an External Time signal and a Built-in Buzzer. These functions can be programmed for each day of the week and each time period.

1. Press the [SELECT] button repeatedly until the ▲ corresponds to the "TIME TABLE PROGRAM" on the setting panel. The set number should be flashing "01"
2. Press [SET] to enter the time table program setting for the set.
3. Press [+] [-] button to select the weekdays for setting.

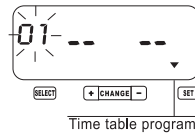

	Day of the week		Day of the week
1.	Monday only	6.	Saturday only
2.	Tuesday only	7.	Sunday only
3.	Wednesday only	8.	Monday to Friday
4.	Thursday only	9.	Monday to Saturday
5.	Friday only	10.	Every day

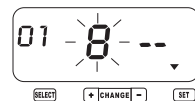

4. Press [SET] to confirm the setting value.
5. Press [+] [-] button to select the "Action" for that set.

	Action
1.	Special mark "*" ON
2.	Special mark "*" OFF
3.	Ext. Signal ON
4.	Built-in Buzzer ON

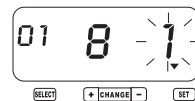

6. Press [SET] to confirm the setting value.

7. Press [+] [-] button to select the hours.
8. Press [SET] to confirm the setting value.
9. Press [+] [-] button to select the minute
10. Press [SET] to confirm the setting value.

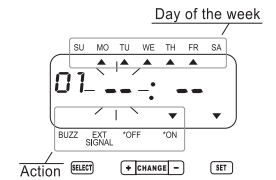

PS. If "Action" 3 or 4 is chosen then the flashing now turns to the duration setting for the signal or the buzzer. The maximum time for setting is 59 seconds.

11. Press [+] [-] button to select the second.
12. Press [SET] to confirm the setting value.
13. Press [+] button to enter the next set of setting.
14. To repeat steps 2-12 to complete the next set of time table program setting.
15. After you finish setting, press the [SET] button once again.

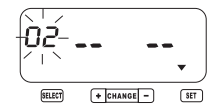
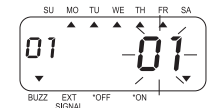

HOW TO DELETE THE TIME TABLE PROGRAM SETTING

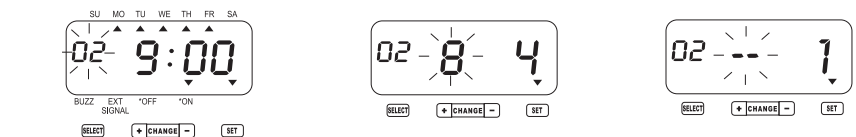

1. Press [+] [-] button to select the desired set number.
2. Press [SET] to enter setting.
3. Press [+] [-] button to select the weekdays setting to be "--".
4. Press [SET] to confirm the setting value then the display turns to "-- --". Now the set is deleted.
5. After you finish setting, press the [SET] button once again.

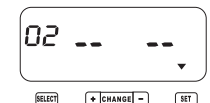

4.10 SETTING THE CUSTOMIZED COMMENTS

In case you choose the number “30” Customized Comments in the setting of “PRINT ORDER”, The Time Stamp can print approximately **25 characters** capacity which depends on the front size each line, and **3 lines comment** can be set to print.

To set your Customized Comment

1. Press the [SELECT] button repeatedly until the ▲ corresponds to the " PRINT ORDER" on the setting panel.
2. Press [+] [-] button to select “30” for Customized Comments ".
3. Press [SET] to confirm the setting value.
4. Press [+] [-] button to select Print Position.

	Print Position
1	Left Orientated
2	Center Orientated
3	Right Orientated

5. Press [SET] to confirm the setting value.
6. Press the [SELECT] button repeatedly until the ▲ corresponds to the " COMMENT" on the setting panel.
7. Now the flashing turns to C1, press [SET] to enter the first comment line for setting.

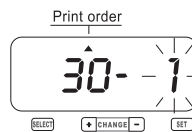
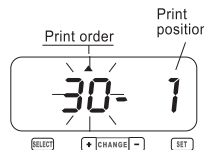
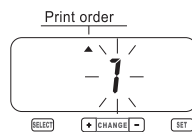

8. Press [SET] to enter the first character for setting.
9. Press [+] [-] button to select the correct character code of character for print.



* Refer to CHARACTER CODE FOR ALPHANUMERIC on page 21

10. Press [+] button to select the next character code for setting.
11. Press [SET] to enter the setting.
12. To repeat steps 3-6 to complete the setting for the first comment line.
13. Press [SET] one again to enter the second comment line for setting.
14. To repeat steps 3-6 to complete the setting for the second comment line.
15. Press [SET] one again to enter the third comment line for setting.
16. To repeat steps 3-6 to complete the setting for the third comment line.
17. After you finish setting, press the [SET] button once again.

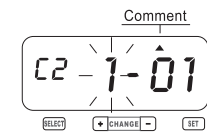

HOW TO CORRECT CUSTOMIZED COMMENTS

Use below code number correction.

Code	Meaning
F8	Insert Character
F9	Delete Character
FA	Insert Line
Fb	Delete Line
FC	Exchange Line 1 to 2
Fd	Exchange Line 2 to 3
FE	Exchange Line 1 to 3
FF	Delete All

RESETTING

To return all setting to the factory defaults, push the reset switch with a pointed implement.

NOTICE: All your custom settings will be deleted and will revert to the factory defaults when the reset switch is pushed. To make new settings, please refer to "Setting...".

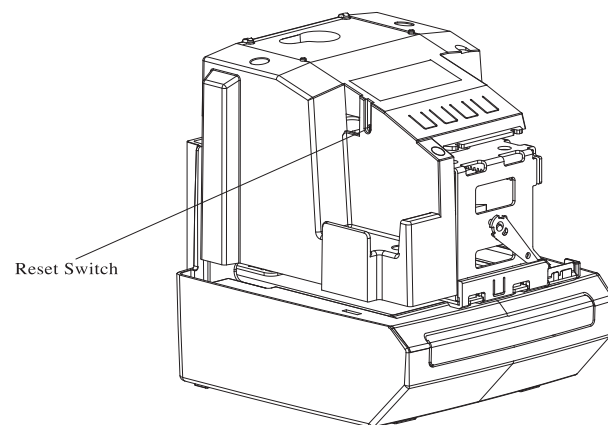

REPLACING THE RIBBON CASSETTE

- 1 Unlock the key and remove the cover.
- 2 Hold the ribbon cassette by its tab and pull straight out to remove it.
- 3 Turn the knob of the new cassette in the direction of the arrow (clockwise) to tighten the ribbon.
- 4 Press the cassette inside the Time Stamp as shown in the figure. Push the ribbon until it snaps into position. Turning the knob on the ribbon cassette may make installation easier.
- 5 Turn the knob of the cassette in the direction of the arrow to tighten the ribbon.
- 6 Replace the cover and lock.

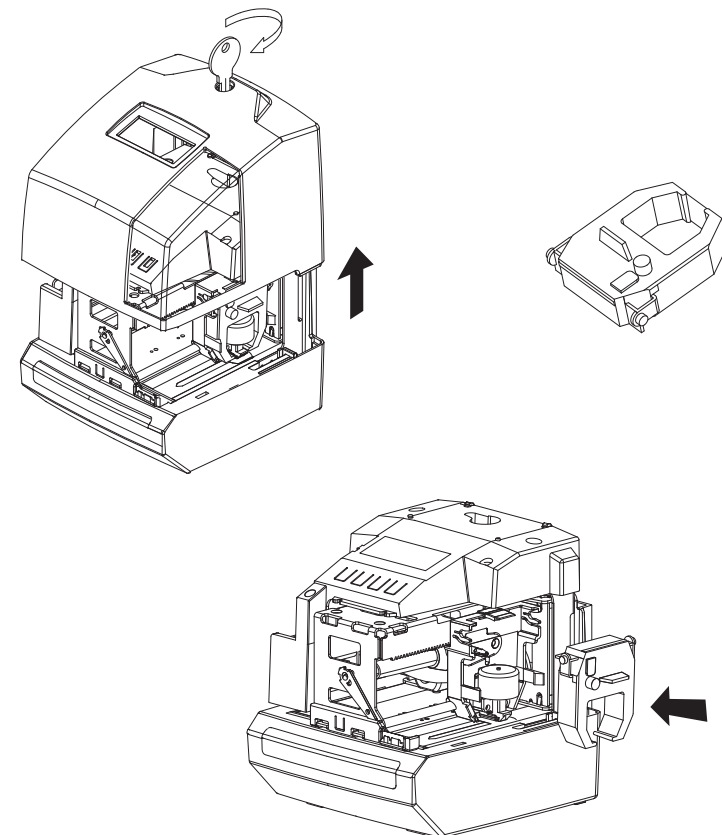

INSTALLING THE Ni-Cd BATTERY (OPTIONAL)

- 1 Unlock the key and remove the cover.
- 2 Insert the battery connector into the compartment connector to install the battery.
- 3 Replace the cover and lock.

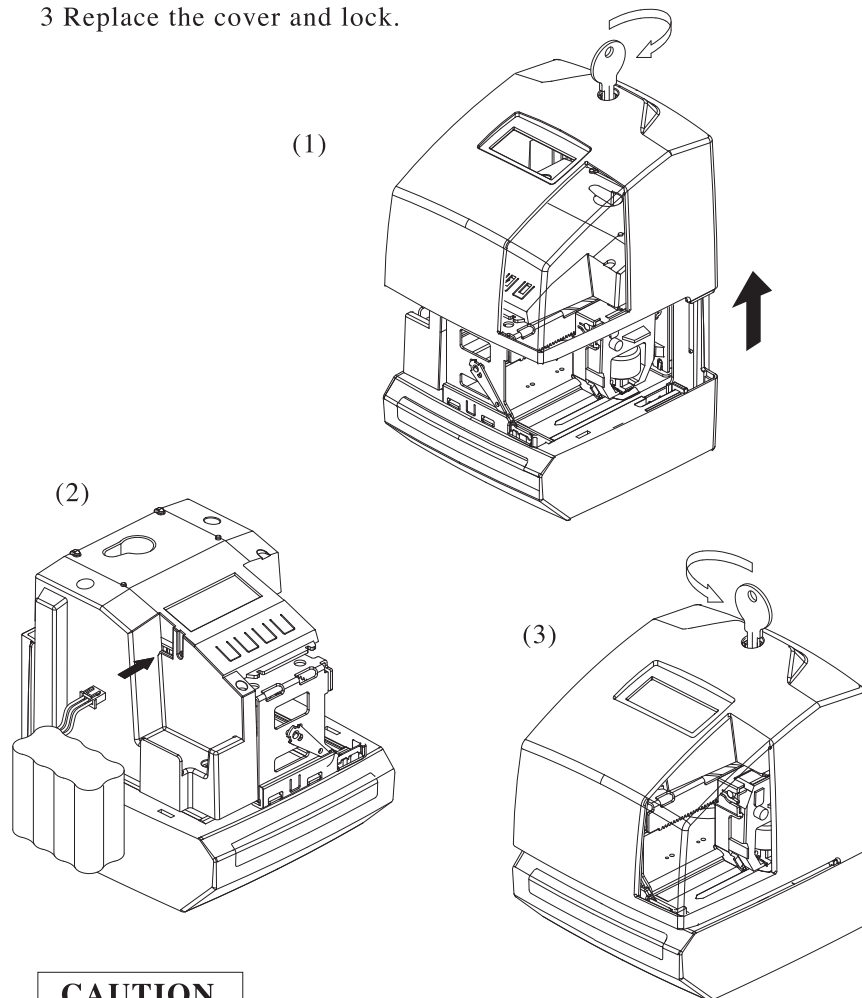

CAUTION

Danger of explosion if battery is incorrectly replaced. Replace only with the same or equivalent type recommended by the manufacturer. Dispose of used batteries according to the manufacture's intructions.

TROUBLE SHOOTING

No.	Error contents
E-03	Cannot print. The printer head motor or the sensor does not operate properly.
E-04	Cannot print. The printer motor or home position sensor is not normal.
E-05	The card is not inserted in the Time Stamp properly.

CHARACTER CODE FOR ALPHANUMERIC

Large (BOLD) Character

Code	Character	Code	Character	Code	Character
02	A	1b	Z	34	※4
03	B	1c	0	35	※5
04	C	1d	1	36	※6
05	D	1E	2	37	※7
06	E	1F	3	38	※8
07	F	20	4	39	※9
08	G	21	5	3A	※10
09	H	22	6	3b	※11
0A	I	23	7	3c	※12
0b	J	24	8	3d	※13
0c	K	25	9	3E	※14
0d	L	26	Year	3F	※15
0E	M	27	Month	40	.
0F	N	28	Date	41	*
10	O	29	DOW	42	+
11	P	2A	HH:MM	43	,
12	Q	2b	HH:MM:SS	44	-
13	R	2c	Number	45	.
14	S	2d	Number	46	/
15	T	2E	Number	47	:
16	U	2F	Number	48	;
17	V	30	Number	49	-
18	W	31	※1	4A	&
19	X	32	※2		
1A	Y	33	※3		

Code=26:2 digits setting of YEAR, Code=2A and 2b:AM/PM setting of HOUR,
Code=2C to 30: Number digits depend on the setting.

Large Character

Code	Character	Code	Character	Code	Character
4b	A	64	Z	78	※4
4c	B	65	0	7E	※5
4d	C	66	1	7F	※6
4E	D	67	2	80	※7
4F	E	68	3	81	※8
50	F	69	4	82	※9
51	G	6A	5	83	※10
52	H	6b	6	84	※11
53	I	6c	7	85	※12
54	J	6d	8	86	※13
55	K	6E	9	87	※14
56	L	6F	Year	88	※15
57	M	70	Month	89	.
58	N	71	Date	8A	*
59	O	72	DOW	8b	+
5A	P	73	HH:MM	8c	,
5b	Q	74	HH:MM:SS	8d	-
5c	R	75	Number	8E	.
5d	S	76	Number	8F	/
5E	T	77	Number	90	:
5F	U	78	Number	91	;
60	V	79	Number	92	-
61	W	7A	※1	93	&
62	X	7b	※2		
63	Y	7c	※3		

Code=6F:2 digits setting of YEAR, Code=73 and 74:AM/PM setting of HOUR,
Code=75 to 79: Number digits depend on the setting.

Small Character

Code	Character	Code	Character	Code	Character
94	A	b5	7	d6	HH:MM
95	B	b6	8	d7	HH:MM:SS
96	C	b7	9	d8	Number
97	D	b8	a	d9	Number
98	E	b9	b	dA	Number
99	F	bA	c	dB	Number
9A	G	bB	d	dB	Number
9B	H	bC	e	dB	*1
9C	I	bD	f	dB	*2
9D	J	bE	g	DF	*3
9E	K	bF	h	EO	*4
9F	L	CO	i	E1	*5
90	M	C1	j	E2	*6
91	N	C2	k	E3	*7
92	O	C3	l	E4	*8
93	P	C4	m	E5	*9
94	Q	C5	n	E6	*10
95	R	C6	o	E7	*11
96	S	C7	p	E8	*12
97	T	C8	q	E9	*13
98	U	C9	r	EA	*14
99	V	CA	s	Eb	*15
9A	W	Cb	t	EC	.
9B	X	Cc	u	Ed	*
9C	Y	Cd	v	EE	+
9d	Z	Ce	w	EF	,
9E	0	Cf	x	FO	-
9F	1	d0	y	F1	.
b0	2	d1	z	FO	/
b1	3	d2	Year	F3	:
b2	4	d3	Month	F4	;
b3	5	d4	Date	F5	-
b4	6	d5	DOW	F6	&

Code=d2: 2 digits setting of YEAR, Code=d6 and D7:AM/PM setting of HOUR,
Code=d8 to dc: Number digits depend on the setting.

Language-Specific Character

English

	※1	※2	※3	※4	※5	※6	※7	※8	※9	※10	※11	※12	※13	※14	※15
Character	#	\$	@	[\]	^	`	{		}	~	EURO		
Dots	Bold	9	9	9	7	8	7	8	5	7	5	7	7	8	
	Large	7	6	7	6	6	6	4	6	4	6	6	7		
	Small	6	6	6	5	6	5	4	3	5	4	5	6	6	

Spanish

	※1	※2	※3	※4	※5	※6	※7	※8	※9	※10	※11	※12	※13	※14	※15
Character	Pt	\$	@	i	Ñ	¿	´	¨	¨	¨	¨	¨	EURO		
Dots	Bold	11	9	9	5	8	7	5	5	9	7	7	7	8	
	Large	8	6	7	4	7	6	4	4	7	7	6	6	7	
	Small	8	6	6	4	6	6	3	3	7	6	5	6	6	

German

	※1	※2	※3	※4	※5	※6	※7	※8	※9	※10	※11	※12	※13	※14	※15
Character	#	\$	§	Ä	Ö	Ü	^	`	ä	ö	ü	β	EURO		
Dots	Bold	9	9	8	8	8	8	5	7	7	7	8	8		
	Large	7	6	7	7	7	7	6	4	7	6	6	7	7	
	Small	6	6	6	6	6	6	4	3	5	5	5	6	6	

French

	※1	※2	※3	※4	※5	※6	※7	※8	※9	※10	※11	※12	※13	※14	※15
Character	#	\$	à	°	ç	§	^	`	é	ù	è	¨	EURO		É
Dots	Bold	9	9	7	4	7	8	8	5	7	7	7	9	8	8
	Large	7	6	7	4	6	7	6	4	6	6	6	7	7	7
	Small	6	6	6	4	5	6	4	3	5	5	5	7	6	6

Italian

	※1	※2	※3	※4	※5	※6	※7	※8	※9	※10	※11	※12	※13	※14	※15
Character	#	\$	@	°	\	é	^	ù	à	ò	è	ì	EURO		
Dots	Bold	9	9	9	4	8	7	8	7	7	7	5	8		
	Large	7	6	7	4	6	6	6	6	7	6	6	4	7	
	Small	6	6	6	4	6	5	4	5	5	5	5	4	6	

Portuguese

	※1	※2	※3	※4	※5	※6	※7	※8	※9	※10	※11	※12	※13	※14	※15
Character	#	\$	@	[\]	^	`	{		}	~	EURO		
Dots	Bold	9	9	9	7	8	7	8	5	7	5	7	7	8	
	Large	7	6	7	6	6	6	6	4	6	4	6	6	7	
	Small	6	6	6	5	6	5	4	3	5	4	5	6	6	

Numeric

	※1	※2	※3	※4	※5	※6	※7	※8	※9	※10	※11	※12	※13	※14	※15
Character	#	\$	@	[\]	^	`	{		}	~	EURO		
Dots	Bold	9	9	9	7	8	7	8	5	7	5	7	7	8	
	Large	7	6	7	6	6	6	6	4	6	4	6	6	7	
	Small	6	6	6	5	6	5	4	3	5	4	5	6	6	

CAUTION

- 1.The unit can be only indoor use. Do not install them outdoors or where they are exposed to rain or in a location near heat radiators or air dusts out let 、moisure 、rain 、mechanical shock vibration.
- 2.Always plug the unit the correct source.
- 3.Should not any liquid or solid object fall into the unit.
- 4.Do not operate this unit with a damaged cord or plug of after the unit malfunction, or damaged in any manner.
Return the unit to authorized service facility for examination, repair or adjustment.
- 5.Unplug the unit and have it check be qualified personal before operate the unit any further.
- 6.The socket-outlet shall be installed near the equipment and shall be easily accessible.

SPECIFICATION

POWER RATING	220-240V~ (refer to the indication on the label of each machine)
AMP	0.2Amp
DIMENSION	16.5 X 15 X 18cm ³ (D x W x H)
WEIGHT	2.5KGS
AMBIENT	0°C-40°C
CONDITION	10-80% RH

